

Notice

F-16C

scale 1:144

Page 2/3



F-16C_144_N_FDM

Page 4/6



F-16C_144_A_FDM

Page 7/9



F-16C_144_C_FDM

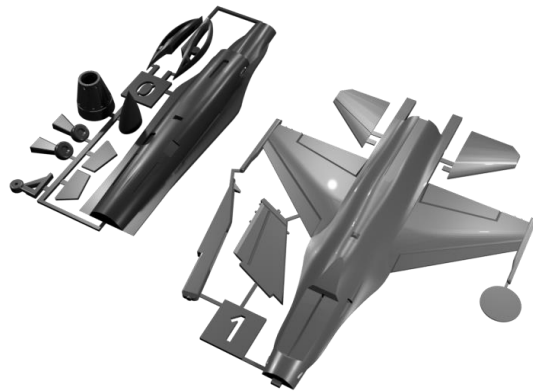

1

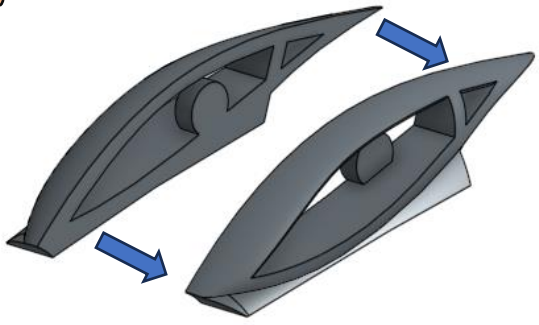

2

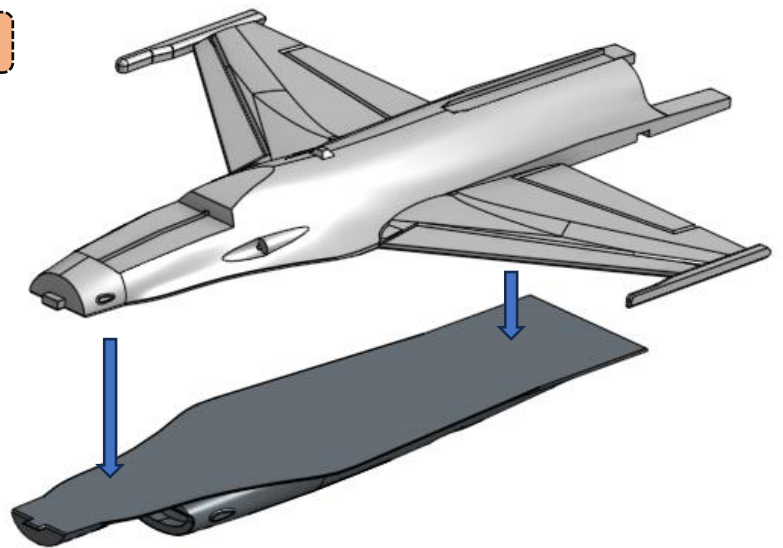

3

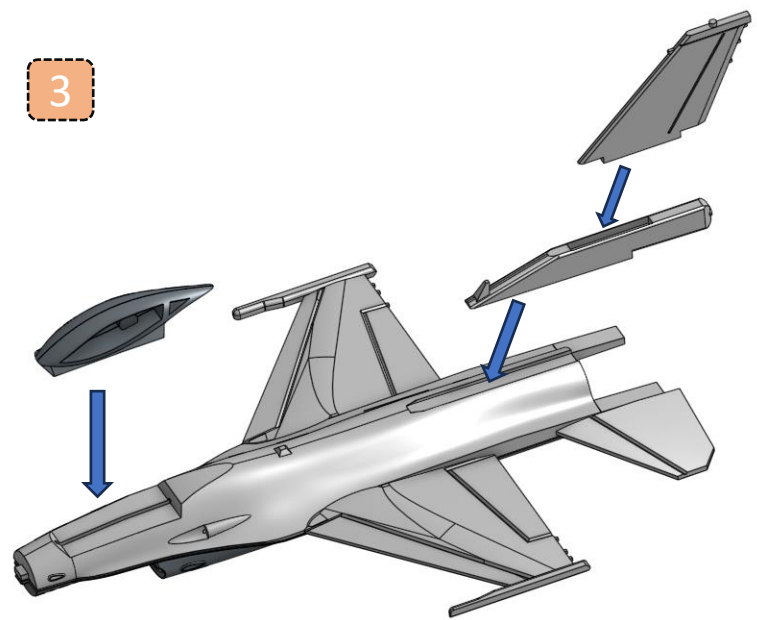

4

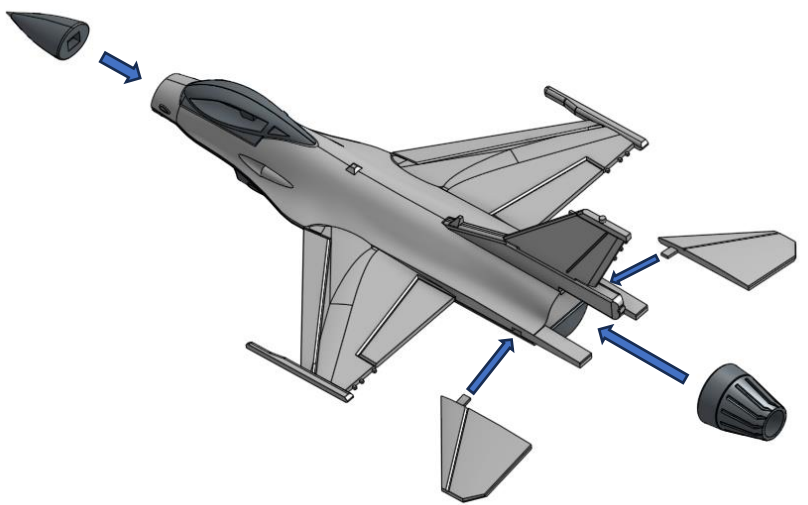

Stabs angles View

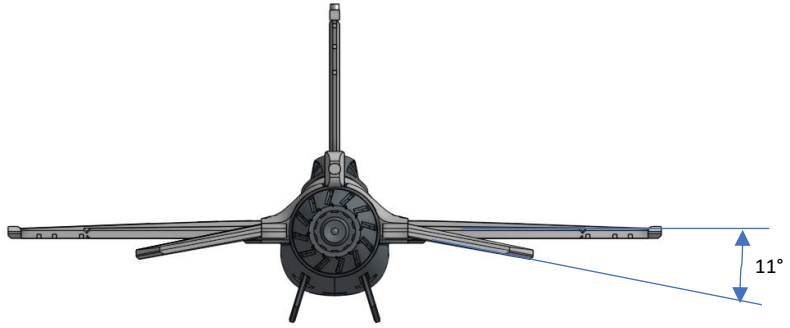

5

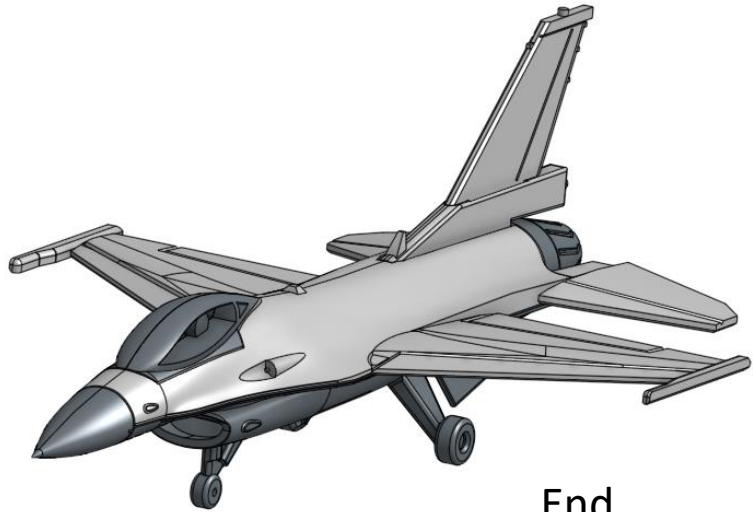
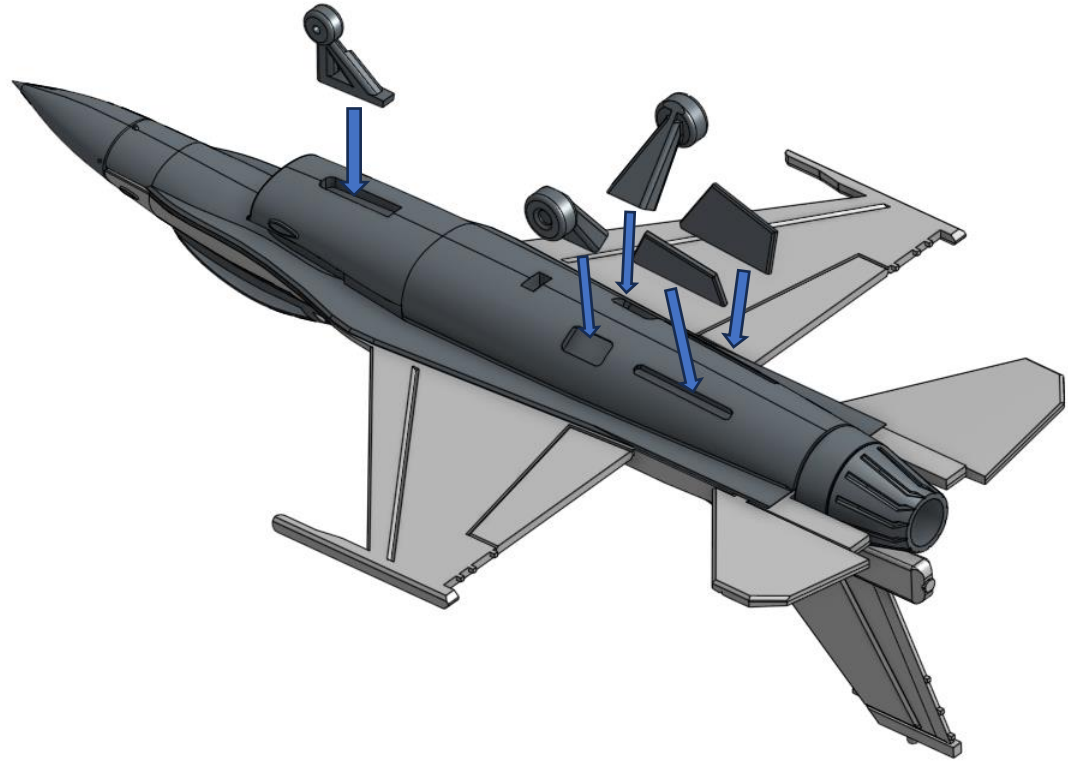

End

1

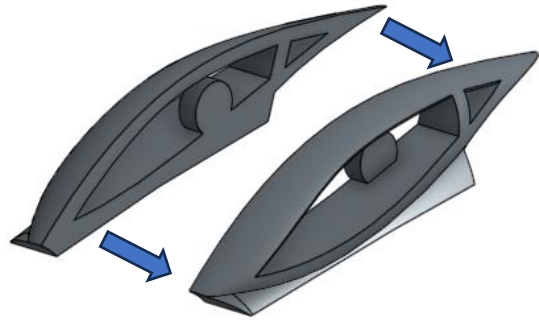

2

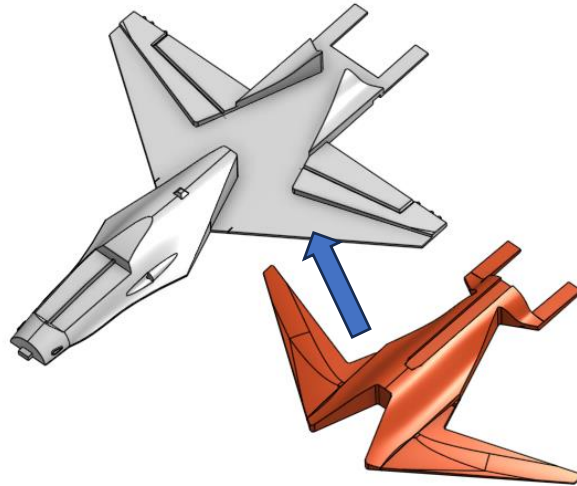

3

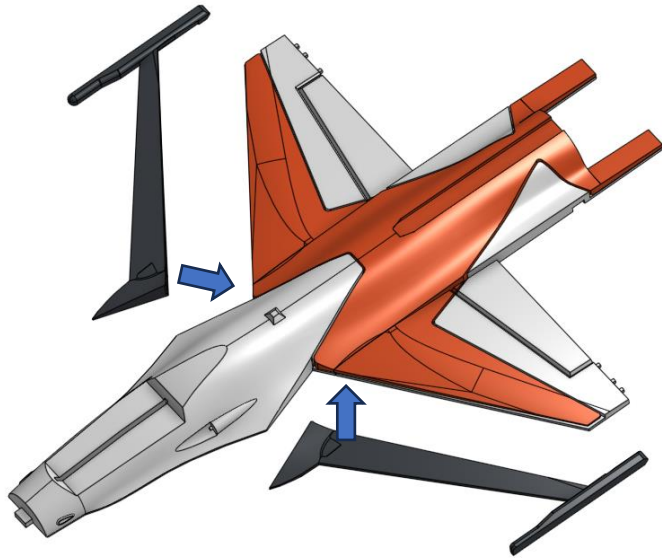

4

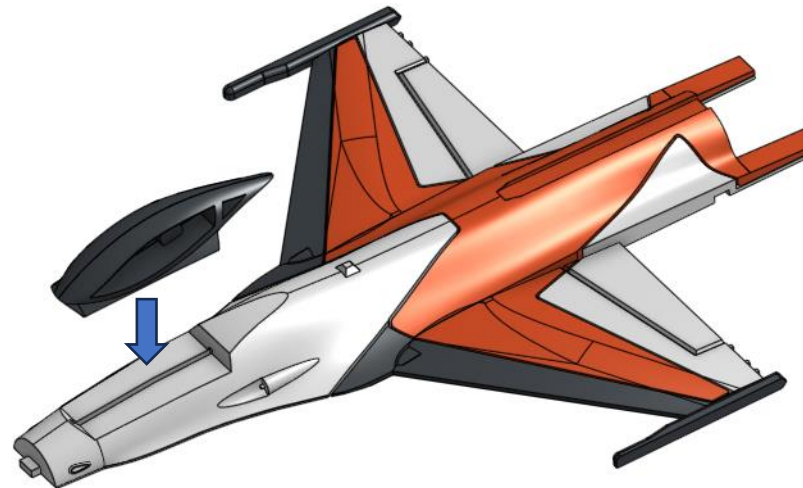

/!\ Use a flat surface to assure the alignements

5



6

(Optional)

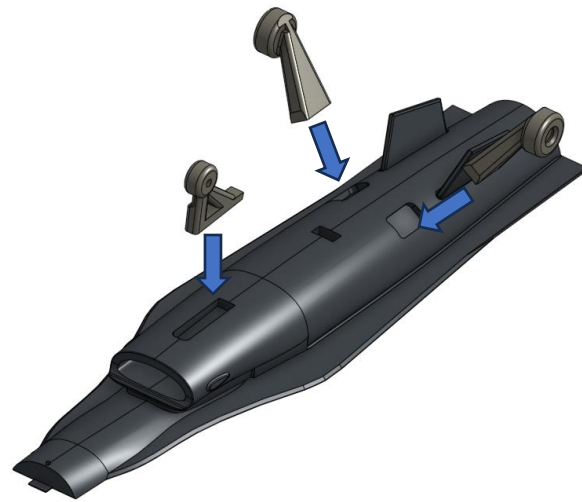

7

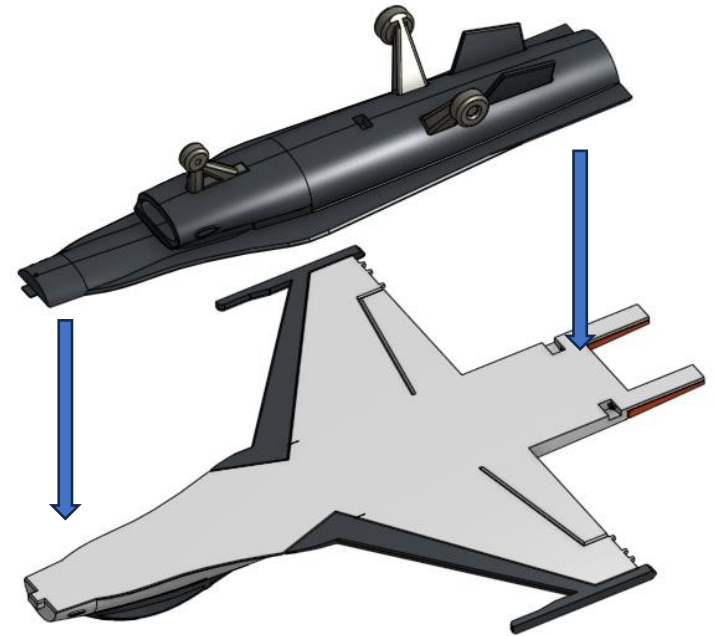

8

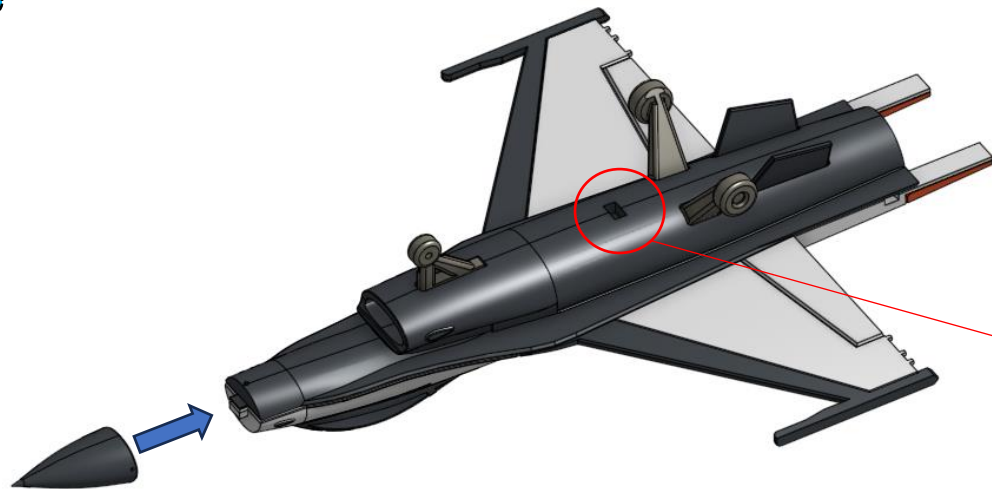

Stand position hole

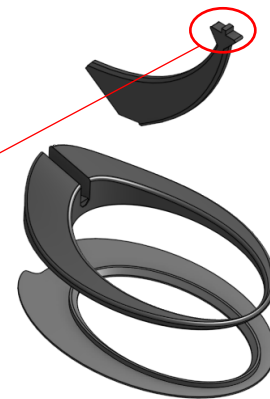

9

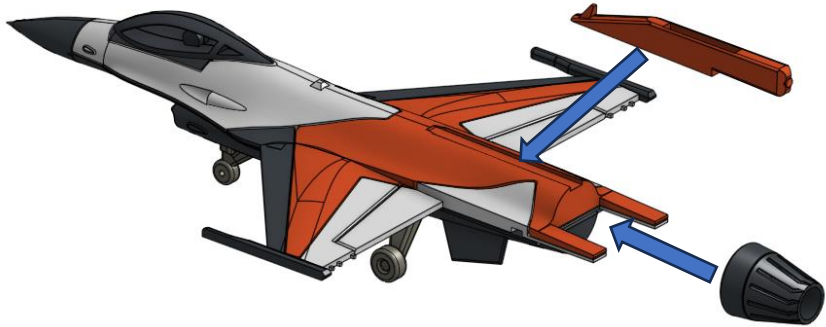

10

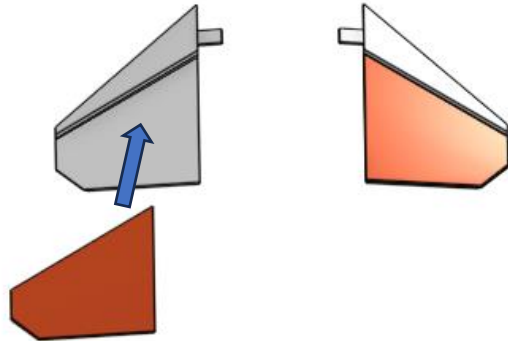

11

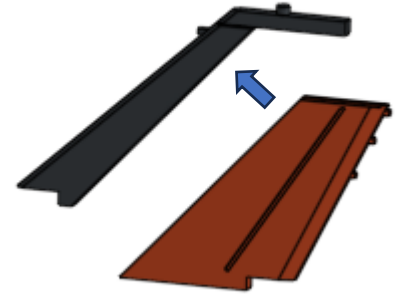

/!\ Use a flat surface to assure the alignements

12

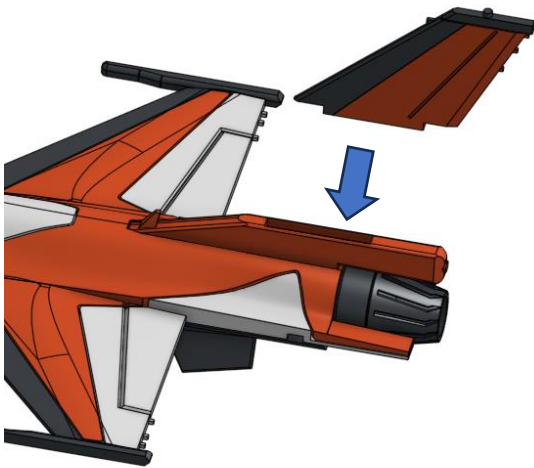

13

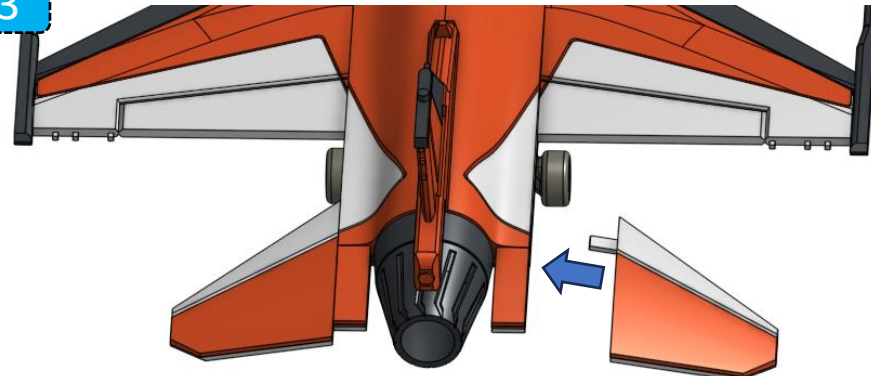

Stabs angles View

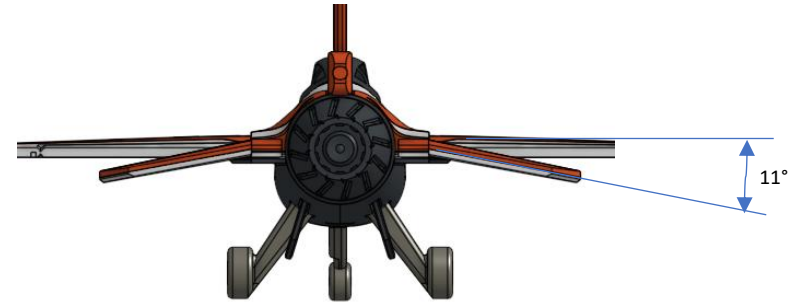

End

1

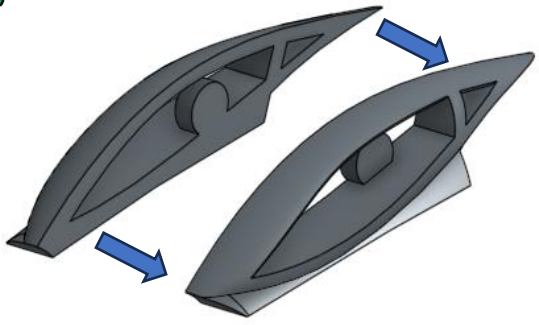

3

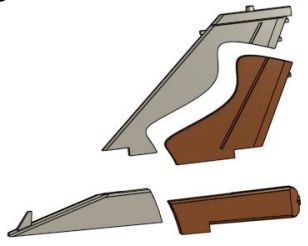

! Use a flat surface to assure the alignements

2

Recompose the puzzle :

! Use a flat surface to assure the alignements

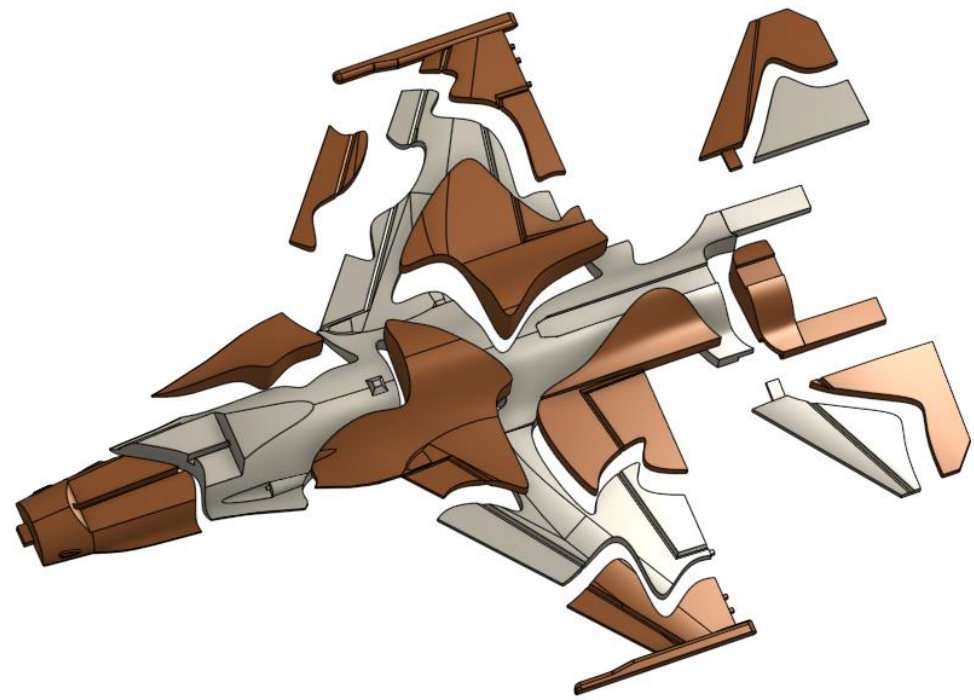

4

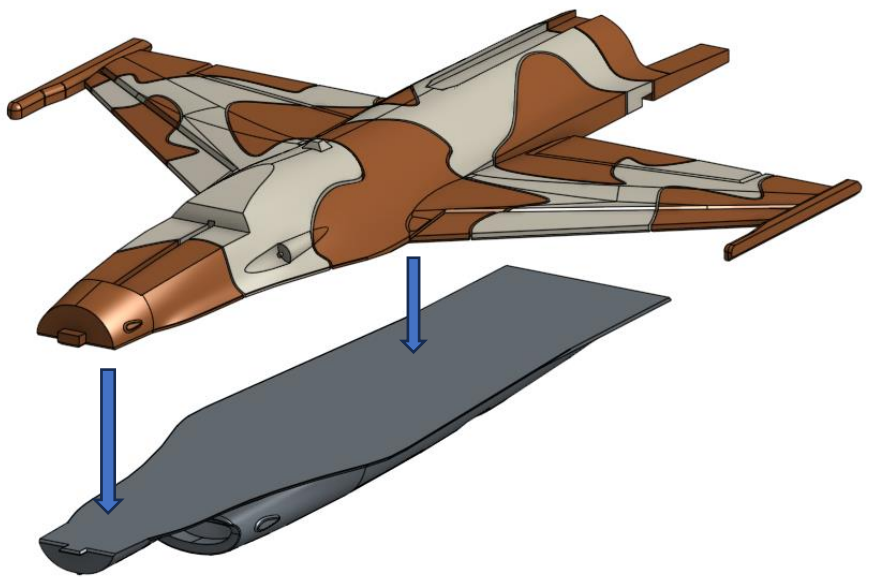

5

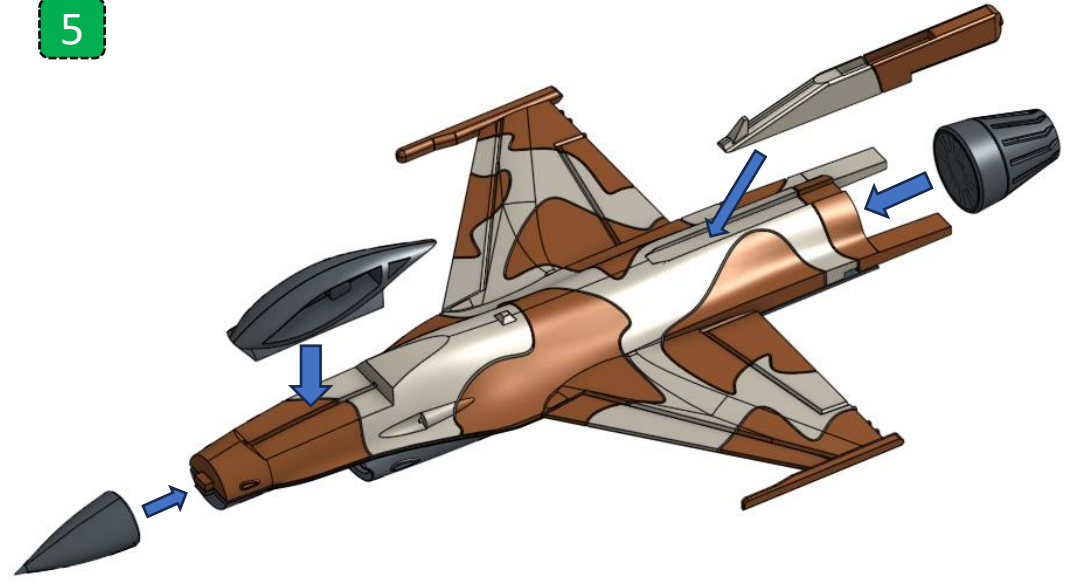

6

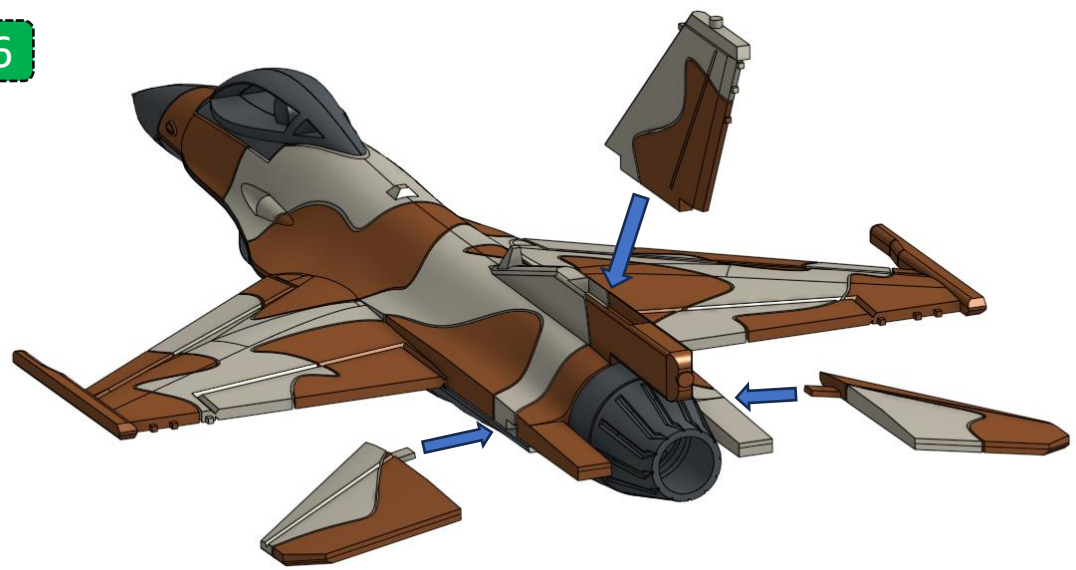

Stabs angles View

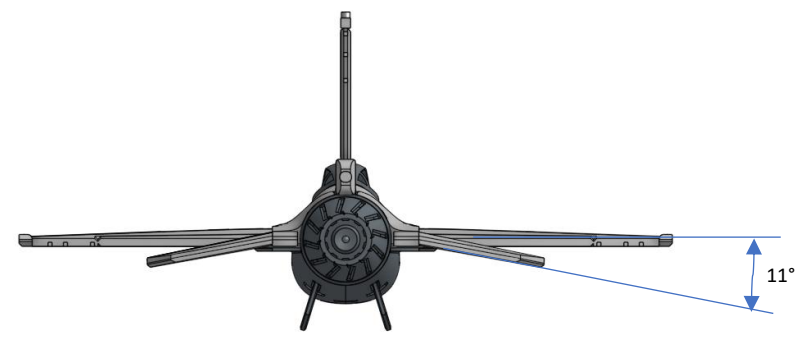

7

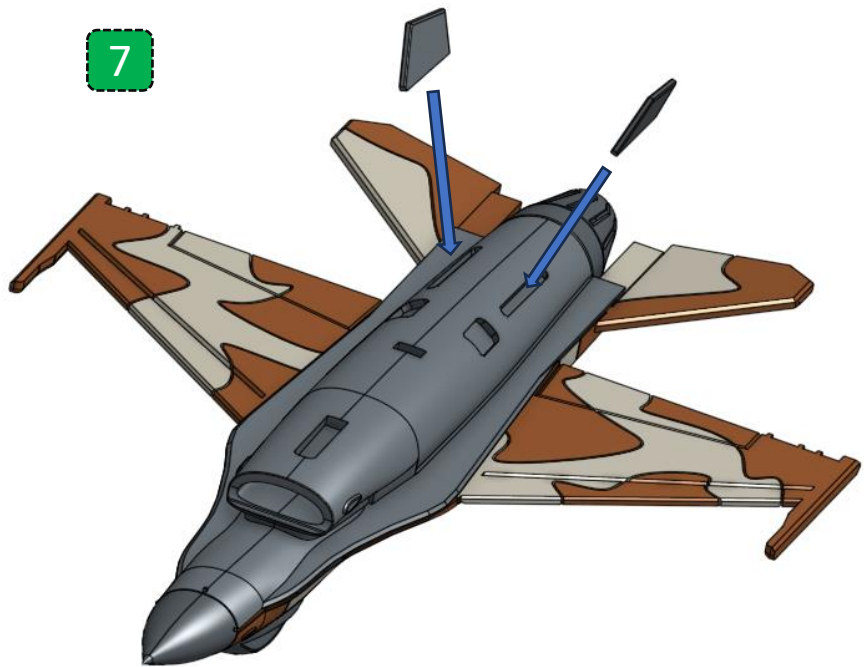

8

option

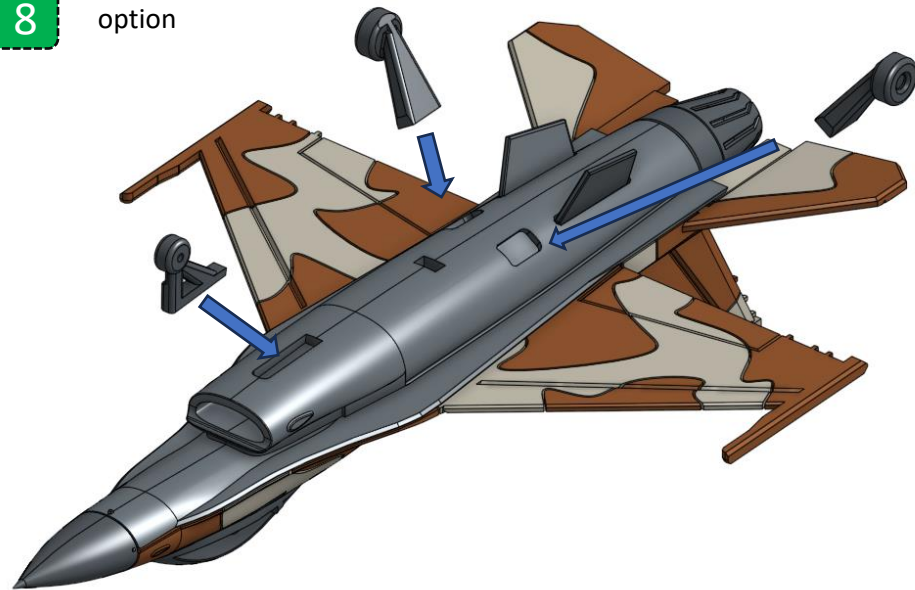

9

option

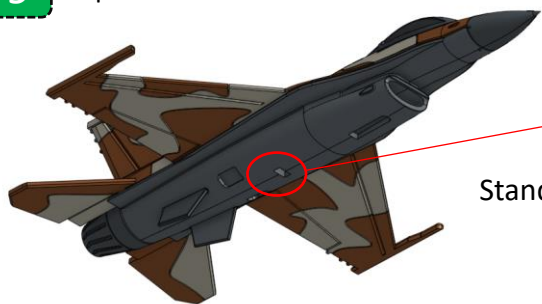

Stand position hole

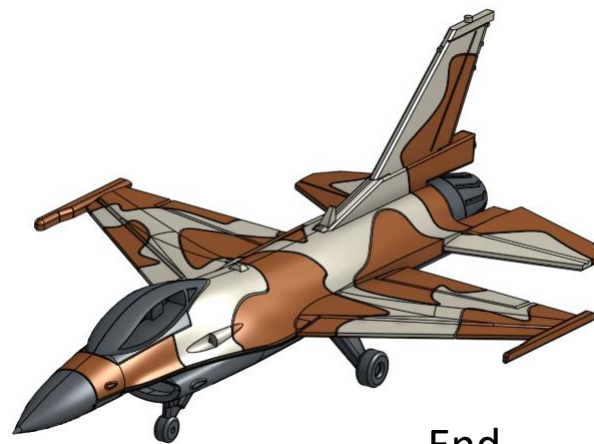
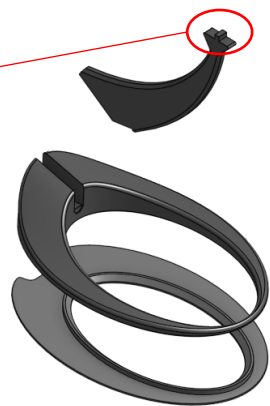

End